

TAMRON

M117FM08-RG

- High contrast and resolution
- 2.4µm pixel pitch
- Rugged mechanical design
- Ultra low distortion



P/N		M117FM08-RG
Imager Size		1/1.7"
Mount		C
Focal Length		8mm
Aperture		F/2.4 - F/16
Angle of View (horizontal x vertical)	1/1.7"	52.2° x 39.5°
	1/1.8"	50.9° x 35.1°
	1/2"	44.5° x 33.8°
	1/3"	33.8° x 25.6°
Focusing Range		0.1m - ∞
Operation	Focus	Manual w/lock
	Iris	Manual w/lock
Filter Size		M30 P=0.5
Wave Length		Visible Light
TV Distortion		-0.85%
Overall Length		38.61mm
Maximum Diameter		32.5mm
Weight		48g
Operating Temperature		-20 ~ 60°C

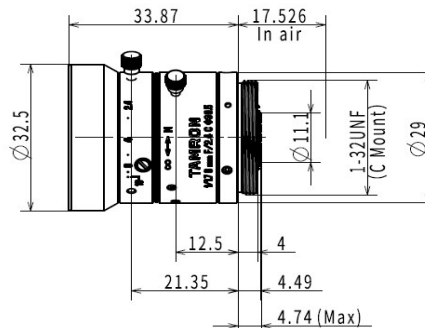
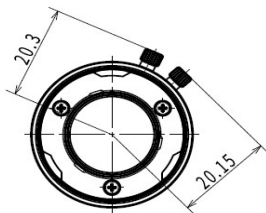

TAMRON Europe GmbH - Robert-Bosch-Str. 9 - 50769 Köln

Phone: +49 (0) 221 / 669544-0 - Mail: cctv@tamron.de - Web: www.tamron.vision